

Rev	Description	By	Date
1	Preliminary	TM	22-Oct-20

ELECTRICAL SPECIFICATIONS @ 25°C

L(per wdg): 4.2mH Min @ 10kHz, 0.1Vrms
 DCR(per wdg): 5.0 mΩ Max
 Irms: ΔT≤40°C @17A
 Turns Ratio: 1:1:1±0T
 (1-2):(3-4):(5-6)
 Polarity: 1, 3 and 5 are in phase
 Hipot: 2kVac, 1mA Max, 10s (wdg to wdg)
 Operating Temperature: -40 °C to +125 °C
 RoHS Compliant: Yes

DIMENSIONS

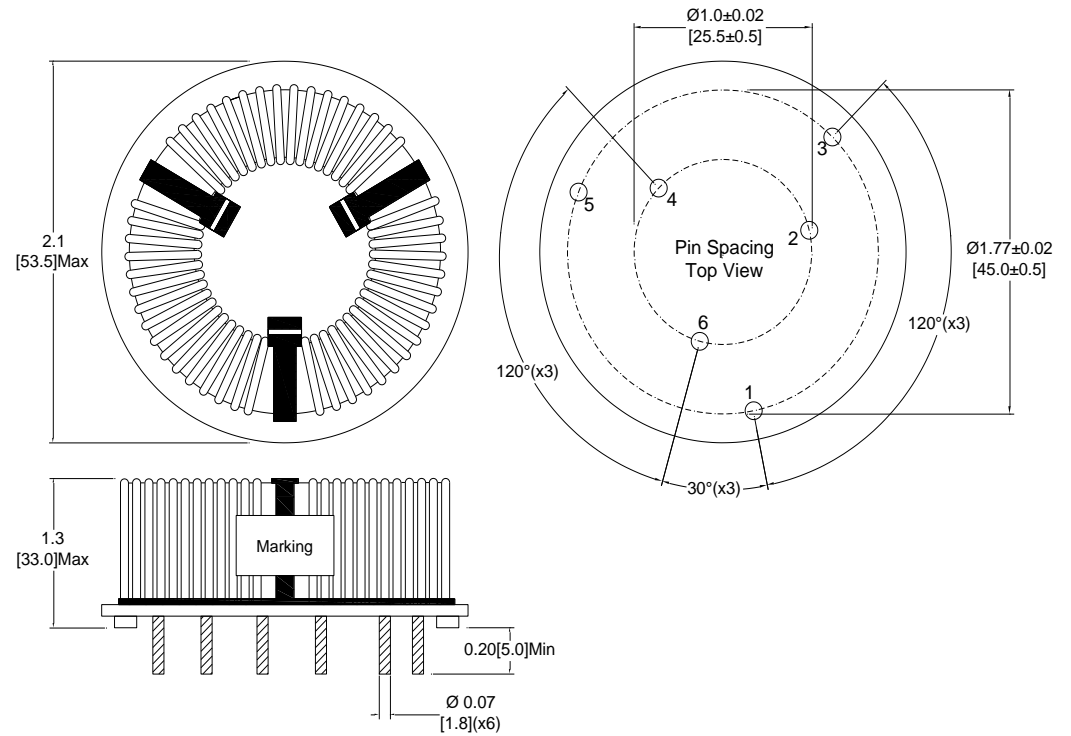

SCHEMATIC

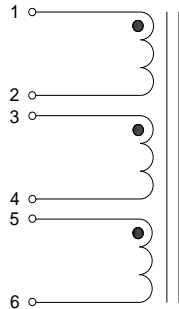

MARKING

MPS
 P57TP40H-422_Rev
 Date Code

Dimensions: inch/[mm]

Notice of Proprietary Property These drawings and specifications are the property of MPS and shall not be reproduced, copied or used as the basis of manufacture of sale of apparatus without express written authorization				 MPS INDUSTRIES, INC. www.mpsind.com Tel: (310) 325-1043 Fax: (310) 325-1044			
						Description	
Dimensions Unless otherwise specified .XX ± .010" [0,254mm] .XXX ± .005" [0,13mm]		DRAWN BY: CHECKED BY:	TM AG	22-Oct-20 27-Oct-20	SIZE A	Part Number P57TP40H-422	REV 1
				WEIGHT: 90 gms		SHEET: 1 OF 1	