

Rev	Description	By	Date
1	Preliminary	AY	29-Sep-20

ELECTRICAL SPECIFICATIONS @ 25°C

L(per wdg): 1.9mH Min @ 10kHz, 0.1Vrms
 DCR(per wdg): 8.5mΩ Max
 Irms: ΔT≤40°C @ 13A
 Turns Ratio: 1:1:1±0T
 (1-2):(3-4):(5-6)
 Polarity: 1, 3 and 5 are in phase
 Hipot: 2kVac, 1mA Max, 10s (wdg to wdg)
 Operating Temperature: -40 °C to +125 °C
 RoHS Compliant: Yes

DIMENSIONS

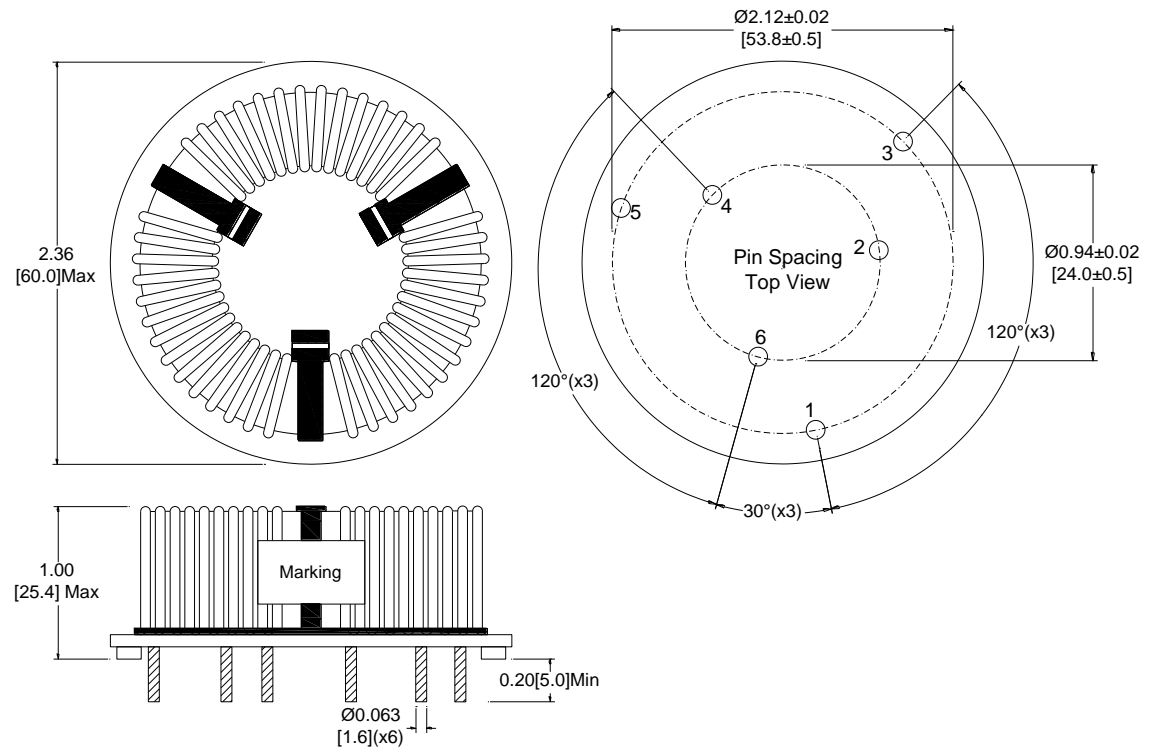

SCHEMATIC

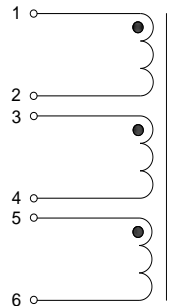

MARKING

MPS
 P56TP48H-192_Rev
 Date Code

Dimensions: inch/[mm]

Notice of Proprietary Property

These drawings and specifications are the property of MPS and shall not be reproduced, copied or used as the basis of manufacture of sale of apparatus without express written authorization

Dimensions Unless otherwise specified .XX ± .010" [0,254mm] .XXX ± .005" [0,13mm]	DRAWN BY: CHECKED BY:	AY AG	29-Sep-20 2-Oct-20
---	--------------------------	----------	-----------------------



MPS INDUSTRIES, INC.

www.mpsind.com

Tel: (310) 325-1043 Fax: (310) 325-1044

Description

3-Phase CMC

Part Number

P56TP48H-192

REV

1

WEIGHT: 90 gms

SHEET: 1 OF 1